

| | |
|----------|--|
| PROJECT | |
| TYPE | |
| NOTES | |
| QUANTITY | |
| DATE | |

WILLY 60 SUSPENSION

D81014-BLK

GENERAL

Series: Willy
 Subseries: Willy 60
 Brand: Panzeri
 Division: Design
 Mounting Type: Suspension
 Mounting Location: Ceiling
 Subcategory: Pendant

PHYSICAL

Shape: Dome
 Diameter (mm): 600
 Diameter (in): 23 5/8
 Height (mm): 370
 Height (in): 14 7/16
 Max. Overall Height (mm): 2370
 Max. Overall Height (in): 93 5/16
 Light Distribution: Direct / Indirect
 Weight (kg): 10.22
 Weight (lbs): 22.53
 Diffuser: Black Blown Glass Dome and Frosted White Glass Bottom Diffuser
 Fixture Material: Glass / Aluminum
 Cable Details: 2000mm (78 3/4") Long Steel Suspension Cables / 2200mm (86 5/8") Long Power Cable In Transparent PVC

ELECTRICAL

Number of Lamps: 3
 Lamp Type: LED Retrofit
 Bulb Included: Bulb Not Included
 Total Output Wattage (W): 45
 Max. Wattage Per Lamp (W): 15
 Lamp Base: E26
 Input Voltage (V): 120

LED

OPTICAL

RATINGS AND CERTIFICATIONS

Certified By: CSA Certified to UL and CSA Standards
 IP rating: IP20

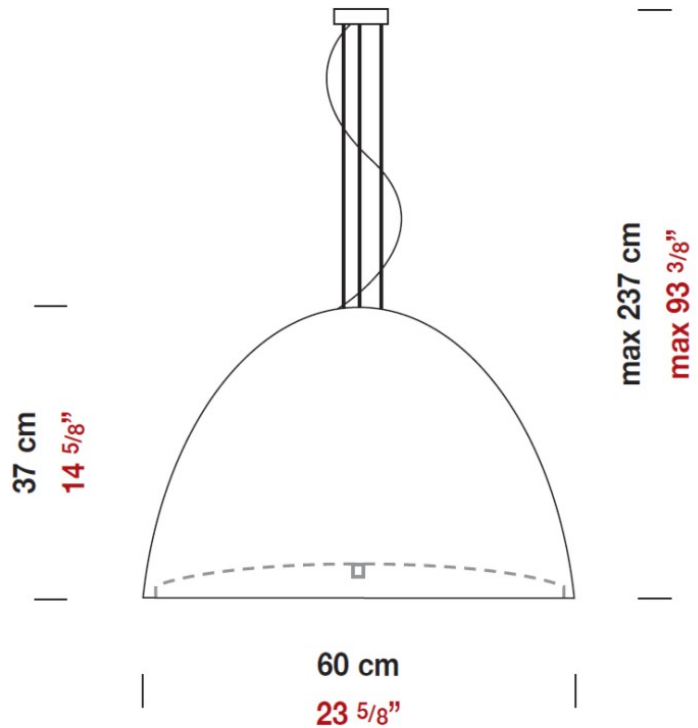

| | |
|----------|--|
| PROJECT | |
| TYPE | |
| NOTES | |
| QUANTITY | |
| DATE | |

WILLY 40 SUSPENSION

D81057-BLK

GENERAL

Series: Willy
 Subseries: Willy 40
 Brand: Panzeri
 Division: Design
 Mounting Type: Suspension
 Mounting Location: Ceiling
 Subcategory: Pendant

PHYSICAL

Shape: Dome
 Diameter (mm): 400
 Diameter (in): 15 3/4
 Height (mm): 280
 Height (in): 11
 Max. Overall Height (mm): 2280
 Max. Overall Height (in): 89 3/4
 Light Distribution: Direct
 Weight (kg): 4.09
 Weight (lbs): 9.02
 Diffuser: Black Blown Glass Dome and Frosted White Glass Bottom
 Fixture Finish: BLK
 Holder Finish: Metallized Gray
 Fixture Material: Blown Glass Lampshade
 Cable Details: 2000mm (78 3/4") Long Steel Suspension Cables / 2200mm (86 5/8") Long Power Cable In Transparent PVC

ELECTRICAL

Number of Lamps: 1
 Lamp Type: LED Retrofit
 Lamp Shape: A19
 Bulb Included: Bulb Not Included
 Total Output Wattage (W): 15
 Max. Wattage Per Lamp (W): 15
 Lamp Base: E26
 Driver Included: No
 Input Voltage (V): 120

LED

OPTICAL

RATINGS AND CERTIFICATIONS

Certified By: CSA Certified to UL and CSA Standards
 IP rating: IP20

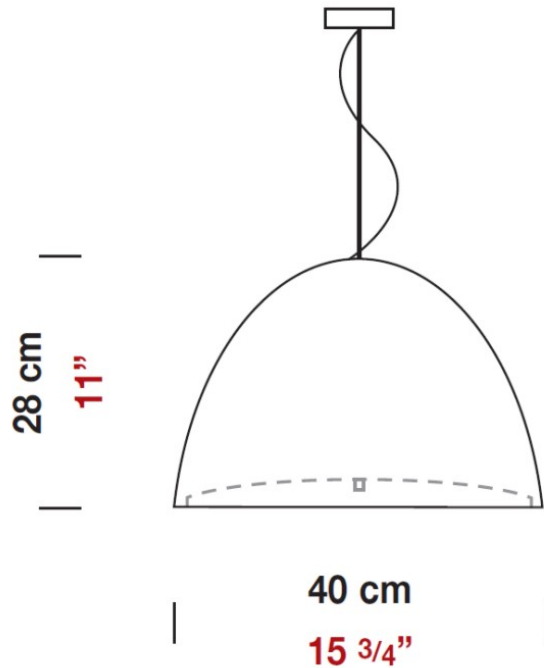

WILLY 40 SUSPENSION

D81057-WHI

GENERAL

Series: Willy

Subseries: Willy 40

Brand: Panzeri

Division: Design

Mounting Type: Suspension

Mounting Location: Ceiling

Subcategory: Pendant

PHYSICAL

Shape: Dome

Diameter (mm): 400

Diameter (in): 15 3/4

Height (mm): 280

Height (in): 11

Max. Overall Height (mm): 2280

Max. Overall Height (in): 89 3/4

Weight (kg): 4.09

Weight (lbs): 9.02

Diffuser: White Blown Glass Dome and Frosted White Bottom

Fixture Finish: WHI

Holder Finish: Metallized Gray

Fixture Material: Blown Glass Lampshade

ELECTRICAL

Number of Lamps: 1

Lamp Type: LED Retrofit

Bulb Included: Bulb Not Included

Total Output Wattage (W): 15

Max. Wattage Per Lamp (W): 15

Lamp Base: E26

Driver Included: No

Input Voltage (V): 120

LED

OPTICAL

RATINGS AND CERTIFICATIONS

Certified By: CSA Certified to UL and CSA Standards

IP rating: IP20

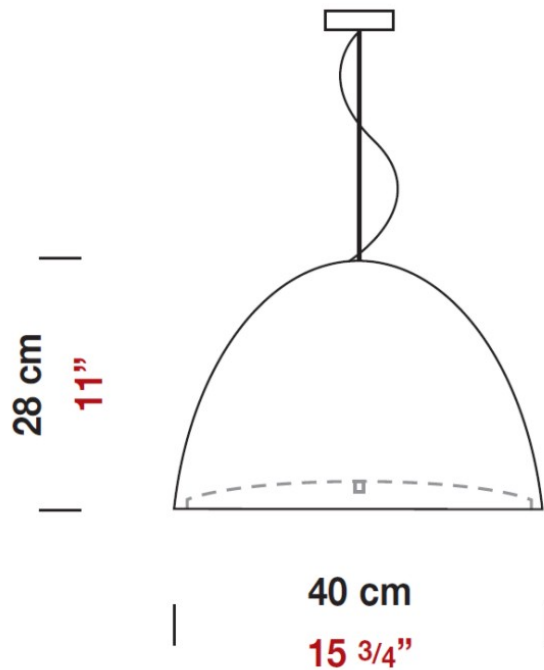

WILLY SUSPENSION

D81060

GENERAL

Series: Willy
Brand: Panzeri
Division: Design
Mounting Type: Suspension
Mounting Location: Ceiling
Subcategory: Pendant

PHYSICAL

Shape: Bell
Diameter (mm): 160
Diameter (in): 6 ¼
Height (mm): 250
Height (in): 9 ⅞
Max. Overall Height (mm): 2250
Max. Overall Height (in): 88 ⅞
Light Distribution: Direct
Weight (kg): 1.23
Weight (lbs): 2.7
Diffuser: Black Blown Glass
Fixture Finish: Metallic Gray
Fixture Material: Metal

ELECTRICAL

Number of Lamps: 1
Lamp Type: LED Retrofit
Lamp Shape: T4
Bulb Included: Bulb Not Included
Total Output Wattage (W): 3
Max. Wattage Per Lamp (W): 3
Lamp Base: G9
Input Voltage (V): 120

LED

OPTICAL

RATINGS AND CERTIFICATIONS

Certified By: CSA Certified to UL and CSA Standards
IP rating: IP20

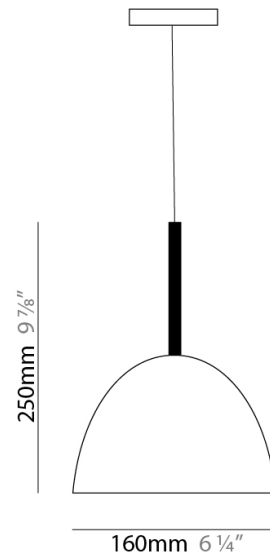

| | |
|----------|-------|
| PROJECT | _____ |
| TYPE | _____ |
| NOTES | _____ |
| QUANTITY | _____ |
| DATE | _____ |

WILLY SUSPENSION

D81344

GENERAL

Series: Willy
Brand: Panzeri
Division: Design
Mounting Type: Suspension
Mounting Location: Ceiling
Subcategory: Pendant

PHYSICAL

Shape: Bell
Diameter (mm): 600
Diameter (in): 23 5/8
Height (mm): 370
Height (in): 14 9/16
Max. Overall Height (mm): 2370
Max. Overall Height (in): 93 5/16
Light Distribution: Direct
Weight (kg): 12.2
Weight (lbs): 27
Diffuser: Metallic Gray Aluminum Dome and Frosted White Glass Bottom Diffuser
Fixture Finish: ALU
Fixture Material: Aluminum

ELECTRICAL

Number of Lamps: 3
Lamp Type: LED Retrofit
Bulb Included: Bulb Not Included
Total Output Wattage (W): 45
Max. Wattage Per Lamp (W): 15
Lamp Base: E26
Input Voltage (V): 120
Upon Request: 277Vac / GU24

LED

OPTICAL

RATINGS AND CERTIFICATIONS

Certified By: CSA Certified to UL and CSA Standards
IP rating: IP20

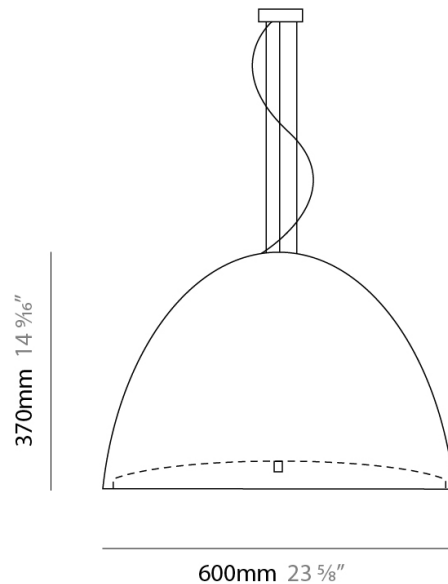

WILLY SUSPENSION

D81564-BLK

GENERAL

Series: Willy
Brand: Panzeri
Division: Design
Mounting Type: Suspension
Mounting Location: Ceiling

PHYSICAL

Diameter (mm): 1000
Diameter (in): 39 ³/₈
Height (mm): 630
Height (in): 24 ¹³/₁₆
Max. Overall Height (mm): 2630
Max. Overall Height (in): 103 ⁷/₁₆
Light Distribution: Direct
Weight (kg): 15.2
Weight (lbs): 33.5
Diffuser: Black Polyethylene Dome and White Frosted Opal Glass Bottom Diffuser
Fixture Material: Polyethylene Lampshade
Cable Details: Transparent

ELECTRICAL

Input Wattage Range: 30 - 49 W
Lamp Type: LED
Input Wattage (W): 40
Total Output Wattage (W): 40
Driver Included: Yes
Driver Type: Integral LED Driver in Canopy
Constant Current (MA): 1050

LED

Color Temperature (°K): 3000
Max. Delivered Lumen (lm): 3859
CRI: >80 CRI
Efficiency (%): 78.12

OPTICAL

RATINGS AND CERTIFICATIONS

Certified By: CSA Certified to UL and CSA Standards

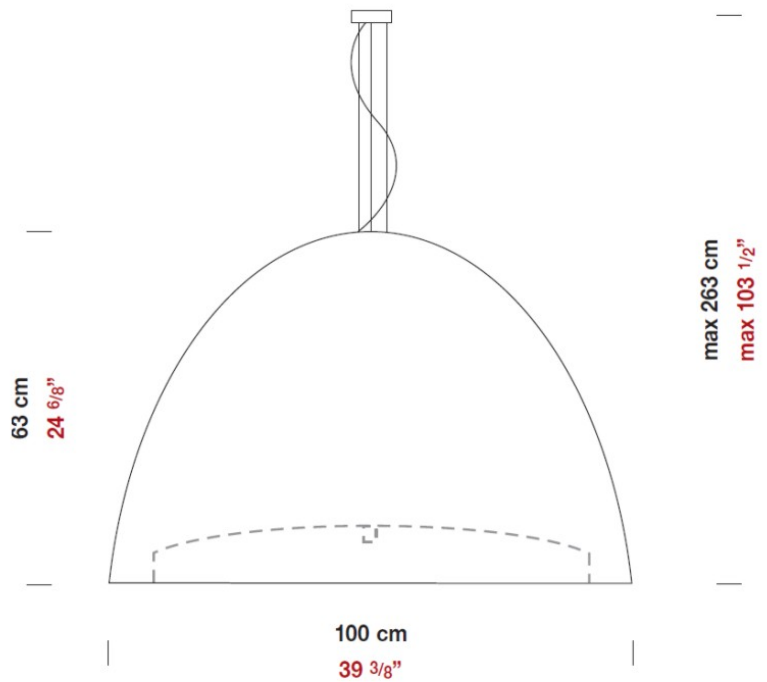

| | |
|----------|-------|
| PROJECT | _____ |
| TYPE | _____ |
| NOTES | _____ |
| QUANTITY | _____ |
| DATE | _____ |

WILLY SURFACE

D83027

GENERAL

Series: Willy
Brand: Panzeri
Division: Design
Mounting Type: Surface
Mounting Location: Wall
Subcategory: Uplight

PHYSICAL

Shape: Dome
Length (mm): 260
Length (in): 9 7/8
Height (mm): 210
Height (in): 8 1/4
Extension (mm): 130
Extension (in): 5 1/8
Light Distribution: Omnidirectional
Weight (kg): 1.63
Weight (lbs): 3.6
Diffuser: Matte White Blown Glass
Fixture Finish: Metallic Gray
Fixture Material: Glass / Aluminum

ELECTRICAL

Number of Lamps: 1
Lamp Type: LED Retrofit
Lamp Shape: T4
Bulb Included: Bulb Not Included
Total Output Wattage (W): 5
Max. Wattage Per Lamp (W): 5
Lamp Base: G9
Input Voltage (V): 120

LED







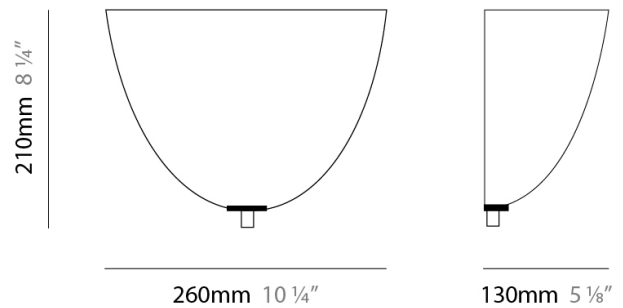





























































OPTICAL

RATINGS AND CERTIFICATIONS

Certified By: CSA Certified to UL and CSA Standards
IP rating: IP20



LEGEND

| | | | | | |
|--|---|---|--|---|--|
|  | floor-mounted |  | pivotal |  | special LED (upon request) RGB, RGBW, tunable, gold+, meat+, art+, fashion+ |
|  | wall and ceiling: recessed and surface mounted |  | rotating |  | warm dim / natural dimming LED |
|  | ceiling-mounted and wall-mounted |  | illuminate tilted |  | rechargeable battery powered |
|  | wall-mounted |  | color of suspension cable |  | fixture with natural vivid LED (upon request) |
|  | omni-directional light distribution |  | length of suspension cable |  | color rendering index |
|  | direct light distribution |  | reflector degree selection |  | color temperature |
|  | direct/indirect light distribution |  | super spot |  | lumen (luminous flux) |
|  | indirect light distribution |  | lens |  | efficacy (lumens per watt) |
|  | asymmetric light distribution |  | lens pack |  | Unified Glare Rating (UGR) range from 5-40 |
|  | aura light distribution |  | shine ring |  | marine grade (AISI 316 stainless steel) |
|  | round wall or ceiling cut-out |  | integrated shine ring with diffuser |  | walk on |
|  | square wall or ceiling cut-out |  | free individual colors 01-29 |  | drive on |
|  | the supplied jig specifies the cutout dimensions |  | individual colors: 00 (free of charge), 01-25 (extra charge) |  | Dark Sky Compliance |
|  | minimum distance (meters) lamp - object |  | luminaire part to be colored (F1) |  | Americans with Disabilities Act (less than 4" off the wall located between 27"-84" from floor) |
|  | recessed depth |  | luminaire part to be colored (F2) |  | lamp protected against explosion |
|  | ceiling thickness in mm |  | luminaire part to be colored (F3) |  | blown glass using traditional methods by master glass blower |
|  | ceiling thickness selection |  | luminaire part to be colored (F4) |  | acoustic material |
|  | dimmable DP (phase), DV (0-10V), DD (dali), DS (step-dim) |  | luminaire part to be colored (F5) |  | protection class I, protection insulation |
|  | included or excluded LED driver/transformer/control gear |  | color of 3-circuit adaptor |  | protection class II, protection insulation |
|  | separately switchable |  | indirect diffuser |  | ETL Certified to UL and CSA Standards |
|  | sensor |  | direct diffuser |  | UL Certified to UL and CSA Standards |
|  | remote control |  | ball-proof (upon request) |  | CSA Certified to UL and CSA Standards |
|  | available upon request |  | accessory |  | Certified for North American Standards |

IP RATING

| | |
|---|--|
|  | protected against ingress of solid bodies greater than 12.5mm (finger) |
|  | protected against ingress of solid bodies greater than 2.5mm protected against sprays of water up to 60 degrees from the vertical (rain) |
|  | protected against ingress of solid bodies greater than 1mm (wire) no protection against the ingress of moisture |
|  | protected against ingress of solid bodies greater than 1mm (wire) protected against sprays of water up to 60 degrees from the vertical (rain) |
|  | protected against ingress of solid bodies greater than 1mm (wire) protected against water splashed from all directions |
|  | protected against limited ingress of dust (wet rooms/covered outdoor areas) protected against water splashed from all directions |
|  | protected against ingress of dust protected against jets of water |
|  | protected against ingress of dust protected against powerful jets of water or heavy seas |
|  | protected against ingress of dust protected against immersion of water between 15cm - 1m for 30 minutes |
|  | protected against ingress of dust protected against immersion of water under pressure for long periods |

IK RATING

| | |
|---|---|
|  | protected against 0.14 joules impact (equivalent to 0.25kg mass dropped from 56mm above the surface) |
|  | protected against 0.2 joules impact (equivalent to 0.25kg mass dropped from 80mm above the surface) |
|  | protected against 0.35 joules impact (equivalent to 0.25kg mass dropped from 140mm above the surface) |
|  | protected against 0.5 joules impact (equivalent to 0.25kg mass dropped from 200mm above the surface) |
|  | protected against 0.7 joules impact (equivalent to 0.25kg mass dropped from 280mm above the surface) |
|  | protected against 1 joules impact (equivalent to 0.25kg mass dropped from 400mm above the surface) |
|  | protected against 2 joules impact (equivalent to 0.5kg mass dropped from 400mm above the surface) |
|  | protected against 5 joules impact (equivalent to 1.7kg mass dropped from 300mm above the surface) |
|  | protected against 10 joules impact (equivalent to 5.0kg mass dropped from 200mm above the surface) |
|  | protected against 20 joules impact (equivalent to 5.0kg mass dropped from 400mm above the surface) |